



Turntable Hi-Fi System

Model: AH6



EUROPEAN REPRESENTATIVE

EU	REP
----	-----

OASIS SERVICE SP. Z O.O.
ul. Młynarska 42 lok.115
01-171 Warszawa

BRITISH REPRESENTATIVE

UK	AR
----	----

UK CROSSBORDER LIMITED
7 Bell Yard London WC2A 2JR,UK
United Kingdom

✉ US.support@angelshorn.com
✉ UK,EU,CA:services@angelshorn.com
🌐 www.angelshorn.com



Introduction

Thank you for purchasing angelshorn Turntable Hi-Fi System with Speakers. This instruction manual contains important information about safety, usage and disposal. Use the product as described and keep this manual for future reference. If you sell this turntable or pass it on, also give this manual to the new owner.

Safety Instructions

Read and understand this entire manual before using this product. Keep these instructions for future reference.

1. Do not use the turntable near water.
2. Only connect the turntable to a power outlet type as indicated on the marking label or in the "Specifications" section of this instruction manual.
3. The turntable has a polarized plug (one pin is wider than the other). To reduce the risk of electric shock, this plug is intended to fit into a polarized outlet in only one orientation. If the plug does not fit fully into the outlet, reverse the plug. If it still does not fit, contact a qualified electrician. Do not attempt to modify the plug in any way.
4. Protect the power cord from being walked on or pinched, particularly at the power plug, at the point of connection between the plug and outlet and at the point of connection between the power cable and speaker.
5. Do not overload wall outlets or extension cords as this will be a fire hazard and may cause electric shock.
6. Never push objects of any kind into the turntable through openings as they may touch dangerous voltage points or short out parts that could result in a fire or electric shock. Never spill liquid of any kind on the product.
7. Do not attempt to service the turntable yourself as opening or removing body panels may expose you to dangerous voltage or other hazards. Refer all servicing to qualified service personnel.
8. Changes or modifications to the turntable not expressly approved by the party responsible for compliance could void the user's authority to operate the product.
9. Do not use attachments not recommended by the manufacturer as they may cause hazards.
10. Only place on a flat, sturdy table or use with the cart, stand, tripod or bracket as specified by the manufacturer or sold with the turntable. When a cart is used, use caution when moving the cart/turntable combination to avoid injury from tip-over.



11. Slots and openings in the cabinet are provided for ventilation and to ensure reliable operation of the product and to protect it from overheating. Do not block or cover these openings.
12. Unplug the product during lightning storms or when unused for long periods of time.

COMPLIANCE WITH FCC REGULATIONS

This device complies with Part 15 of FCC rules. Operation is subject to the following two conditions:

- (1) This device may not cause harmful interference, and
- (2) This device must accept any interference received, including interference that may cause undesired operation.

This equipment has been tested and found to comply with the limits for a Class B digital device, pursuant to Part 15 of the FCC rules. These limits are designed to provide reasonable protection against harmful interference in a residential installation.

This equipment generates, uses and can radiate radio frequency energy and, if not installed and used in accordance with the instructions, may cause harmful interference to radio communications. However, there is no guarantee that interference will not occur in a particular installation.

If this equipment does cause harmful interference to radio or television reception, which can be determined by turning the equipment off and on, the user is encouraged to try to correct the interference by one or more of the following measures:

- Reorient or relocate the receiving antenna.
- Increase the separation between the equipment and receiver.
- Connect the equipment into an outlet on a circuit different from that to which the receiver is connected.
- Consult the dealer or an experienced radio/TV technician for help.

WARNING: Changes or modifications to this unit not expressly approved by the party responsible for compliance could void the user's authority to operate the equipment.

The FCC certification of this device refers to RF exposure testing performed in typical operating conditions, where a person is no closer than 20 centimeters from the device surface at all times, except for non-repetitive patterns with transient time intervals in the order of a second. Only in the stated conditions, the device is shown to fully comply with the FCC RF Exposure requirements of KDB 447498.

WARNING: Cancer and Reproductive Harm - HYPERLINK "<http://www.P65Warnings.ca.gov>."

Product Description

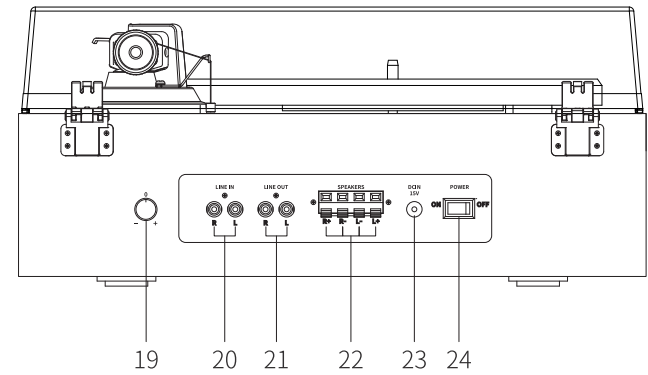
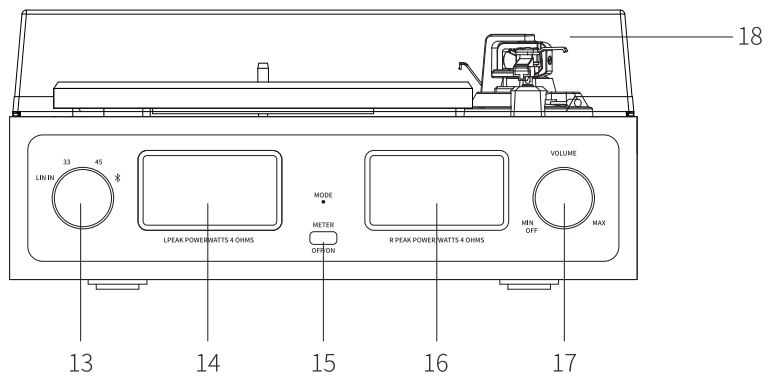
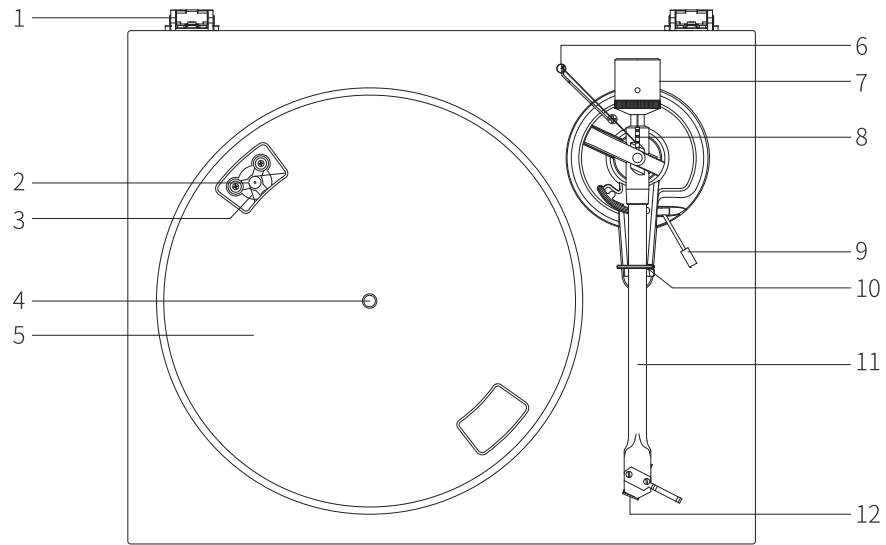

- 1. Lid Hinge
- 2. Motor Pulley
- 3. Drive Belt
- 4. Turntable Spindle
- 5. Turntable Platter
- 6. Anti-skating Weight
- 7. Counterweight
- 8. Anti-skating Stick

- 9. Tonearm Lift Lever
- 10. Tonearm Clip
- 11. Tonearm
- 12. Stylus Cartridge
- 13. 33/45RPM Selector
- 14. Left Peak Power Meter
- 15. Meter Power Button
- 16. Right Peak Power Meter

- 17. Volume Control
- 18. Lid
- 19. Pitch Adjustment Knob
- 20. Line In Jacks
- 21. Line Out Jacks
- 22. External Speaker Jacks
- 23. Power Cord Jack
- 24. Power Switch

Included Items

Before installing the turntable, check the package contents to ensure all parts below are included and free of visible damage. Please retain the original packaging materials for exchange or return purposes.

1 x Turntable Unit	1 x Drive Belt
2 x Speakers	1 x Belt Hook
1 x Turntable Lid	1 x Power Adapter
1 x Slip Mat	2 x Audio Cables for Speakers
1 x Turntable Platter	1 x Cartridge Adjustment Card
1 x Tonearm Counterweight	1 x Instruction Manual
1 x Anti-skating Weight	
1 x 45 RPM adapter	

Installing the Turntable

- Mount the product on a level surface.
- To avoid the effects of vibrations and acoustic pressure, do not mount the product next to such items as speakers.
- The product may pick up radio static if placed next to a radio. Therefore, try to keep the product away from radios.
- If the product is near equipment (cell phone, etc.) that emits strong radio waves, noise may occur.

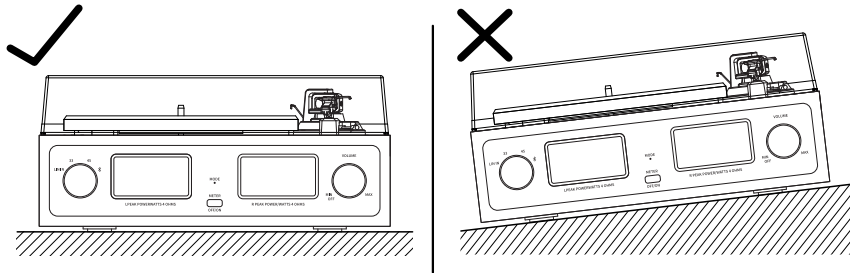

Installing the Lid

Insert the hinge pockets of the lid onto the hinges of the turntable.

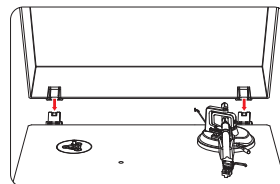

Turntable Platter and Belt Setup

1. Turn the platter over and check the belt position.
Make sure that the drive belt is looped in the middle of the circle. The drive belt located too high or too low in this circle may cause the drive belt to fall off or speed to be unstable.

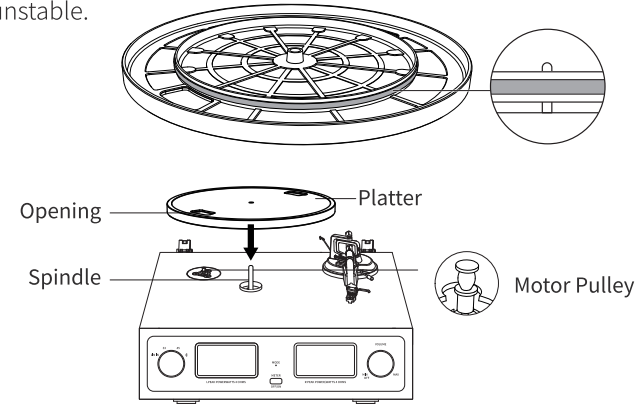

2. Place the belt on the motor pulley.
Align one of the platter openings with the motor pulley, and while pulling both ends of the red ribbon that comes attached to the belt, place the belt on the motor pulley, as per the diagram. When doing this, be careful not to twist the belt.

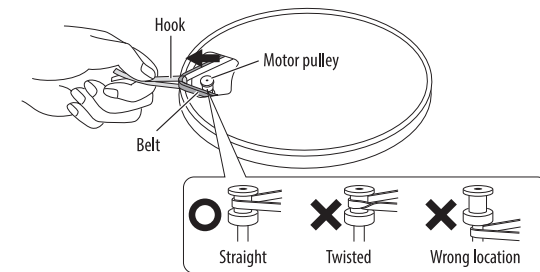

3. Remove the red ribbon from the belt.

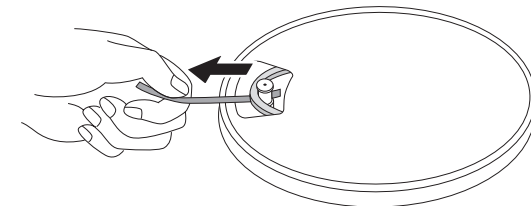

Rotating the Platter

1. Using your hands, slowly rotate the platter ten times in the direction of the arrow (Figure 1).
2. This step is for resetting the auto mechanism, getting rid of any twists in the belt and making sure the belt rides smoothly along the drive rim on the underside of the platter.
3. Place the slip mat on top of the platter. Make sure the AngelsHorn logo on the mat is facing up (Figure 2).

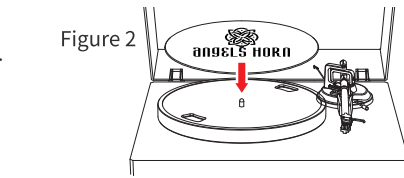
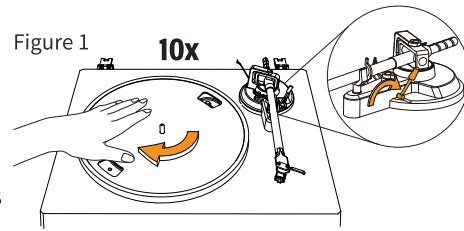

Cartridge Tracking Force Adjustment

The Counterweight supplied is suitable for cartridges weighing between 3.0-6.0g.

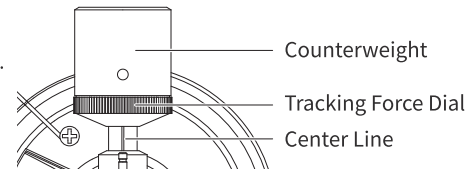

1. Gently push and turn the Counterweight onto the rear of the tonearm (with the dial facing toward the front of the turntable).
2. Pull the protector straight forward to remove it.

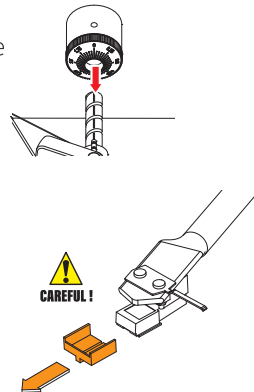

NOTE: Applying a downward force may cause the stylus to come off the body. Only low volume is output if the stylus has come off, or is about to come off, so refer to “Replacing the stylus” to reattach the stylus correctly.

3. Remove the tie-wrap and unlock the tonearm.
4. Lower the tonearm lift lever and position the cartridge in the space between the tonearm rest and platter.

5. Carefully rotate the Counterweight until the tonearm achieves a neutral balance. The tonearm should return to this balanced position if it is moved up or down. This adjustment must be done carefully.

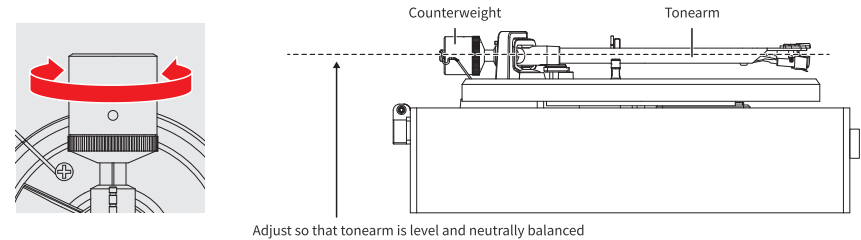

6. Once the tonearm is correctly balanced, return the tonearm to its rest. Hold the Counterweight without moving it, and gently rotate the tracking force dial until the zero is in line with black center line on the rear of the tonearm. Check to make sure the tonearm is still neutrally balanced.

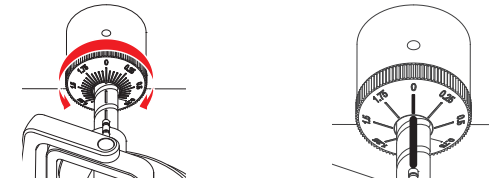

7. Rotate the counterweight counter clockwise (as seen from the front) to adjust the tracking force according to the cartridge manufacturer’s recommendations.

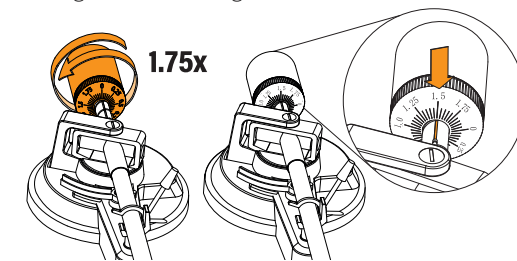

NOTE: Each mark on the scale represents 0.05g. The recommended tracking force for the factory-installed cartridge is $3.5g \pm 0.5g$. The cartridge tracking force only goes up to 2g for one rotation of the tracking force dial. You will need to make more than one rotation to reach 3.5g

Anti-skating Force Adjustment

The anti-skating force must be adjusted corresponding to the tracking force as follows:

Tracking Force	Groove in the Stick
5-10 mN	1st from bearing ring
10-15 mN	2nd from the bearing ring
15-20mN	3rd from the bearing ring
>20mN	4th from the bearing ring

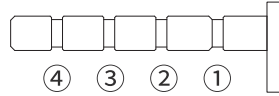

1. Slip the loop of the anti-skating weight's thread over the **3rd** groove of the stick to set the correct anti-skating force for the factory-installed cartridge.

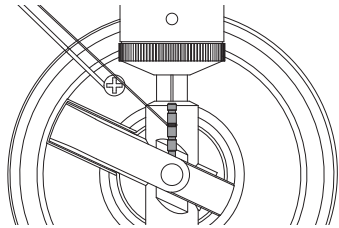

2. Feed the thread through the loop of the wire hanger.

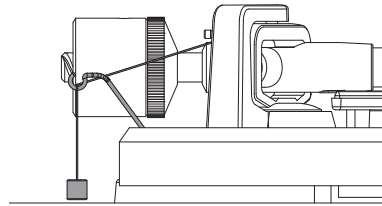

Stereo System Connection

1. Connection to the Included Speakers

This turntable includes a built-in preamp and comes supplied with Hi-Fi speakers. Connect the speakers using the included audio cable (dark cable to black cable clamp and light cable to red cable clamp).

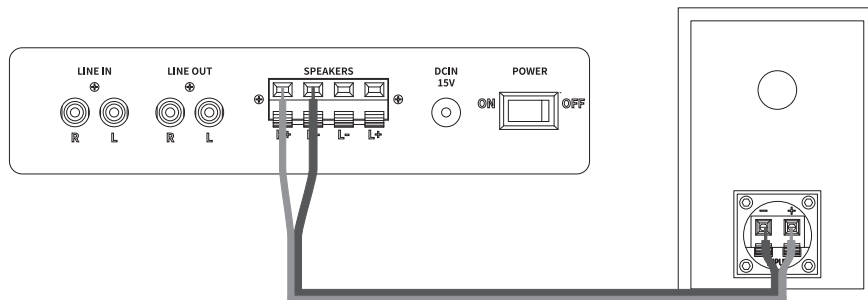

2. Connection to External Speaker with the RCA Audio Cable

This product has a built-in phono equalizer function. You can use the product even if you do not have a phono amplifier or connectable equipment with a built-in phono amplifier. The Line out jacks of this turntable are shared as both the Phono output jacks and the Line output jacks

If you wish to use your own amplifier or speakers, please follow the instructions below:

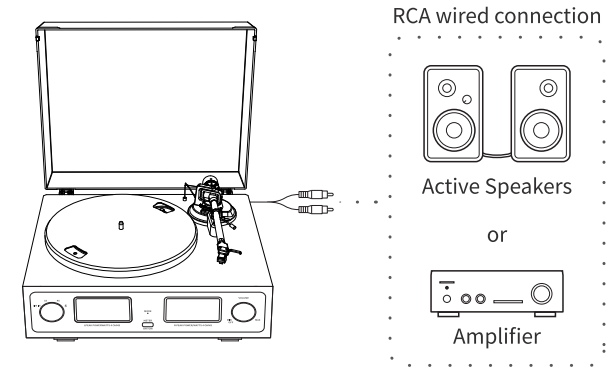

2.1 Connection to the Speaker directly

The RCA Line Out Jacks output analog line-level signals and can be connected directly with a pair of active/powered speakers of the appropriate input of your stereo system.

The Red plug connects with the Right channel and the White plug connects with the Left channel.

NOTE: The RCA Jacks are not designed to be connected directly to passive/unpowered speakers in LINE mode. If connected to the passive speakers, no sound will come out.

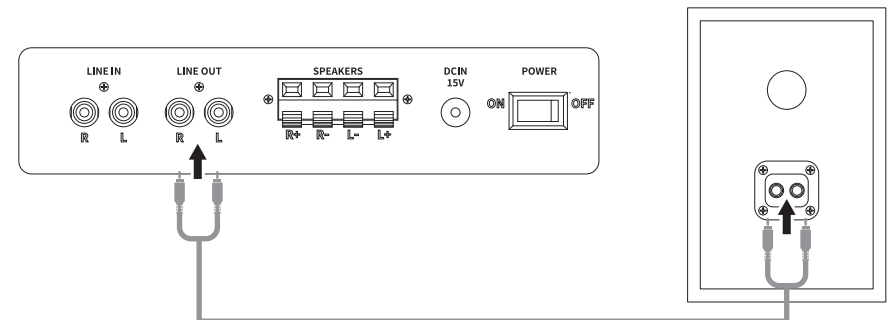

2.2 Connection to an Amplifier

This turntable uses a moving magnetic cartridge. Connect the phono out cables to the phono input on your amplifier or pre-amplifier (phono stage). Line inputs such as CD, Tuner, Tape, or Video are not suitable for phono inputs. Make sure the amplification of the selected input matches the type of cartridge being used. The factory installed cartridge is 47k ohms / MM-input.

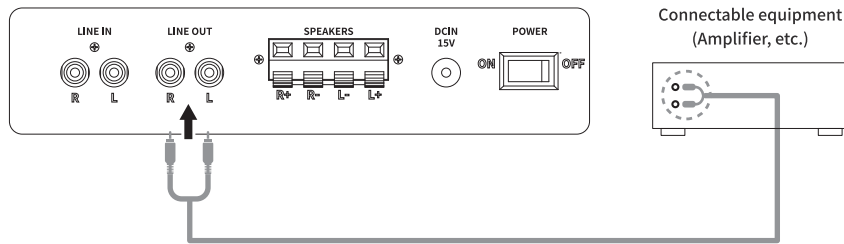

3. Connection to the device by LINE IN jack

If you wish to connect other devices such as Turntable, CD player, radio, DVD player, cassette tape player etc., and this unit is used as an Amplifier and speakers for these devices, please follow the instructions below:

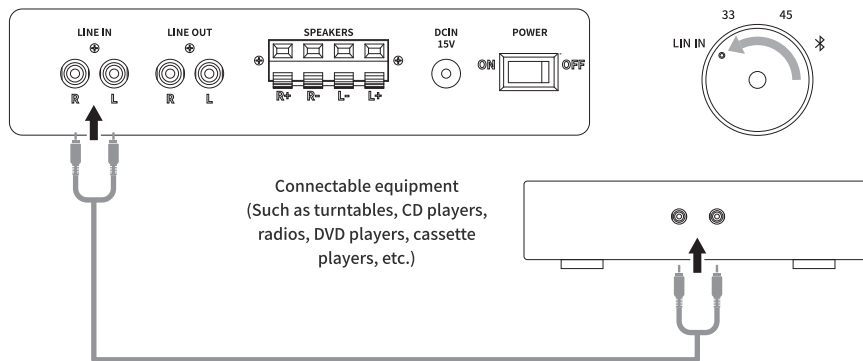

Rotate the Function Knob to LINE IN, and connect the RCA audio cable to an output jack that is compatible with the connectable equipment you are using (Turntable, CD player, radio, DVD player, cassette tape player etc.).

- The RCA audio cable's red jack is for the right (R) channel, and the white jack is for the left (L) channel.

Main Power Connection

1. Insert the DC plug of the AC adapter cord into the DC INPUT Jack at the back of the turntable.
2. Plug the AC adapter into a normal power outlet.

NOTE: Do not plug the AC power adapter into a power outlet before all turntable assembly is completed. Before turning on turntable power, recheck all connections to make sure they are correct and secure. Always turn off the turntable before connecting or disconnecting from power.

Power Management Function

The turntable will automatically go into standby mode after 15 minutes of inactivity. To resume operation, press and hold the Mode button for 3 seconds.

Playing a Record

1. Before playing a record

- 1.1 Pull the protector straight forward to remove it.

NOTE: Applying a downward force may cause the stylus to come off the body. Only low volume is output if the stylus has come off, or is about to come off, so refer to "Replacing the stylus" to reattach the stylus correctly.

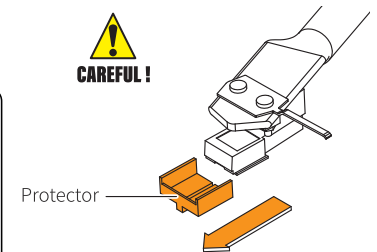

- 1.2 Place the record on the felt mat so that the center hole aligns with the spindle.

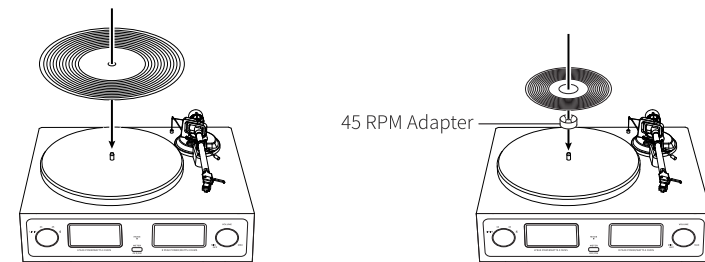

If playing a 45 RPM record with a large center hole, attach the 45 RPM adapter.

2. Turntable Operation

Lower the volume of the amplifier, speakers, etc. sufficiently.

- 2.1 Connect the included power adapter to the turntable and slide the Power Switch to the “ON” position.
- 2.2 Remove the stylus protector from the stylus.
- 2.3 Place the record on the slip mat. If using 45RPM records, put the 45RPM adapter on the center spindle before placing the record on the platter.
- 2.4 Rotate the 33 or 45 RPM speed knob according to the type of records
- 2.5 Unlock the tonearm clip and set the tonearm lift lever to the up position.
- 2.6 Position the tonearm over the desired location (groove) on the record. The platter will start spinning.
- 2.7 Carefully lower the tonearm on the record.
- 2.8 Turn up the volume of the turntable as needed.
- 2.9 When you are finished playing the record, raise the tonearm, return it to rest on the arm clip.



Bluetooth Operation

1. Connect the included power adapter to the turntable and slide the Power Switch to the “ON” position.
2. Rotate the Function Knob to Bluetooth mode. Red indicator light indicates Turntable mode and blue indicator light indicates Bluetooth mode. You will hear an activation sound from the turntable.
3. Turn on the Bluetooth feature of your media device and search for and select “ANGELS HORN AH6” to pair the media device and turntable.
4. Once your media device is successfully paired with the turntable, the turntable will play a short confirmation sound.
5. Play and stream music from your media device to the turntable.

NOTE:Bluetooth version: 5.3

Care

Turntable Body

- When the turntable body is dirty or dusty, first disconnect the AC adapter, and then wipe off the dirt and dust with a soft, dry cloth.
- Do not use benzenes, thinners, etc.
- When storing the product for a long time, disconnect the AC adapter from the outlet and wrap the product in plastic; do not allow it to become damp; the drive belt should be removed to prevent unequal stretching.

Stylus Tip

- If dirt and grime are stuck to the stylus tip, clean it with a commercially sold brush.
- We recommend using a stylus cleaner (not included) if the stylus tip is considerably dirty. Clean the stylus tip by moving the brush from the rear to the front of the stylus tip.

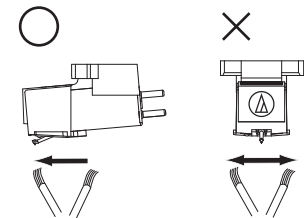

Replacing the Stylus

It's suggested to replace the stylus after 400 hours of use.

Removing the Stylus

- In addition to the deterioration of sound quality, records may also be damaged as the cartridge's stylus tip wears down.
- Be sure to disconnect the product's AC adapter from the outlet.
- When replacing the stylus, hold the headshell and the cartridge body tightly. Rotate the front of the stylus in a forward and down motion.

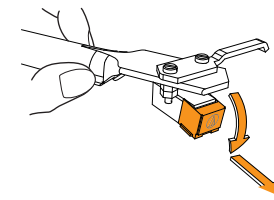

Installing a New Replacement Stylus

1. Mount the new replacement stylus to the cartridge.

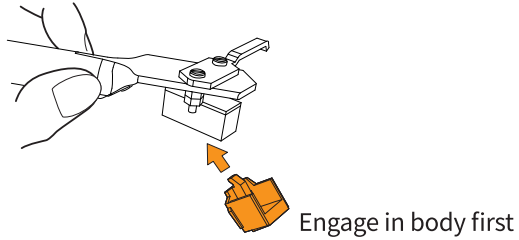

2. Lift the stylus up until you hear a click.

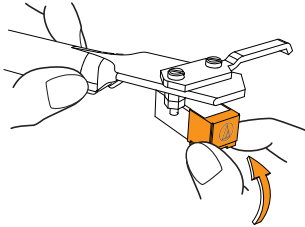

3. Make sure there is no gap between the headshell and the cartridge.

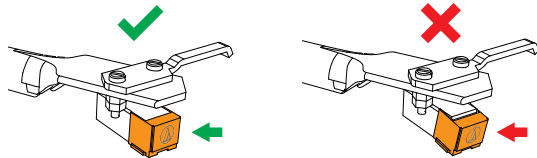

Replacing the Belt

- The belt is a consumable part. Replace the belt if the speed of playback slows down or irregular rotation occurs. As a rule of thumb, we suggest replacing the belt once a year.
- Before replacing the belt, be sure to disconnect the product's AC adapter from the outlet.

When the Turntable is Moved

Using the product's original packing materials, wrap the turntable in the reverse order from when you unwrapped it. If you do not have the packaging materials, take the following measures:

- After disconnecting the AC adapter from the outlet, remove the felt mat and platter, and then wrap them so that they do not get damaged.
- Attach the protector to the cartridge.
- Use a string or something similar to tie the tonearm to the rest so that it does not move.
- Wrap the turntable body with paper or a soft cloth so that it does not get damaged.

Troubleshooting

Problem	Solution
The platter does not spin.	<ul style="list-style-type: none"> • Is the AC adapter connected to the outlet? <ul style="list-style-type: none"> - Connect the AC adapter to the outlet. • What's the status of the indicator light? <ul style="list-style-type: none"> - The indicator light is off. That means the turntable is not turned on. Follow the operation steps to start the turntable. - The indicator light is on. Rotate the function knob to the correct position according to your connection method (via audio cable or Bluetooth). • Has the belt slipped from the platter? <ul style="list-style-type: none"> - Correctly place the belt on the platter. • Is the belt placed on the motor pulley? <ul style="list-style-type: none"> - Check that the belt is placed on the motor pulley (brass-colored) correctly. • Has the belt been damaged? <ul style="list-style-type: none"> - Replace it with a new belt.
The platter spins, but there is no sound or the volume is not loud enough.	<ul style="list-style-type: none"> • Are the function settings and input for connected equipment (amplifier, etc.) selected correctly? <ul style="list-style-type: none"> - Check whether the settings for the connected equipment are correct. • Is the stylus damaged? <ul style="list-style-type: none"> - Check the stylus and replace it, if necessary. • Is the stylus placed correctly on the body of the cartridge? <ul style="list-style-type: none"> - Check the cartridge and adjust it, if necessary • Are the setting positions for the pre-amplifier selector switch correct? <ul style="list-style-type: none"> - If you are connection to the speaker (not the speakers from the pack) with RCA audio cable, check that the pre-amplifier settings are correct, noting the following common problems and their causes: <ul style="list-style-type: none"> - If there is no sound, or if the volume is not loud enough, the product is set to the "PHONO" position and connected to the amplifier's AUX/LINE input. - If the volume is too loud or is distorted, the product is set to the "LINE" position, and the connectable equipment is connected to the PHONO input.

The stylus skips.	<ul style="list-style-type: none"> • Is the record warped? <ul style="list-style-type: none"> - Check the record. • Is the record scratched? <ul style="list-style-type: none"> - Check the record. • Is the tracking force set too light? <ul style="list-style-type: none"> - Adjust the tracking force correctly.
There is howling.	<ul style="list-style-type: none"> • Is the product picking up excessive vibrations from the floor, surfaces of the walls, or nearby speakers? <ul style="list-style-type: none"> - Decrease the vibrations or mount the product on a surface that is not subject to the effects of vibrations. • Is the product mounted on an unstable surface? <ul style="list-style-type: none"> - Check whether the surface on which the product is mounted is suitable.
There is noise when the record is playing.	<ul style="list-style-type: none"> • Is there dust on the cartridge's stylus tip? <ul style="list-style-type: none"> - If dust is stuck to the stylus tip, clean it with a commercially sold brush.
The sound when the record is playing is either too fast or too slow	<ul style="list-style-type: none"> • Are the speed settings for this product correct? <ul style="list-style-type: none"> - Please select the correct speed for the type of record being played.
Playback speed slows down or there is irregular rotation.	<ul style="list-style-type: none"> • Is the belt stretched out? <ul style="list-style-type: none"> - Replace with a new belt. • The motor speed is abnormal and needs to be fine-tuned. <ul style="list-style-type: none"> - Use the adjustment screws to carefully adjust the speed.
Needle is not touching the record.	<ul style="list-style-type: none"> • The screw on the tonearm rest may have loosened during transport. Gently turn this screw clockwise to move the needle stylus closer to the record.
Needle is scratching the record's surface.	<ul style="list-style-type: none"> • Gently turn the tonearm rest screw anticlockwise to move the needle stylus away from the turntable.

NOTE: Factory screw tightness is based on the thickness of the included slip mat. If a thinner or thicker 3rd-party slip mat is used, gently adjust the screw as needed following the steps in the last two trouble shooting topics.

Specifications

Turntable

Power	AC power adapter, DC output 15V 2400mA
Power Consumption	70W
Turntable Speed	33 1/3, 45 RPM
Wow and Flutter	±0.15%
Signal to Noise	-65dB
Tracking Force Range	0-6.0g
Effective Tonearm Length	8.6" (218.5mm)
Dimensions (L x W x H)	16.6" x 13.5" x 7.6" (422x 342 x 193mm)
Weight	13.2lb (6kg)

Stylus

Model	Audio-Technica AT3600L
Frequency Response	20Hz - 20kHz
Channel Balance	<2.5dB
Channel Separation	>18dB
Output Voltage	2.5mV
Recommended Load Resistance	47kΩ
Amplifier Connection	MM (Moving Magnet) - input
Recommended Tracking Force	3.5±0.5g
Weight	0.18oz (5.1g)

Speaker

Output Power	18W*2
Speaker Units	Woofers: 4" Tweeters: 2"
Impedance	4 Ω
Frequency Response	50Hz-20KHz
Dimensions	6.2" x 7" x 9.8" (158 x 177 x 248mm)
Weight	8lbs (3.6kg)

NOTE: Design and specifications are subject to change without notice.

Disposal

Disposal of the Product



Under no circumstances should you dispose of the product in normal domestic waste.

This product is subject to the provisions of European Directive 2012/19/EU. Dispose of the product via an approved disposal company or your municipal waste facility. Please observe currently applicable regulations.

Please contact your waste disposal center if you need any further information.



This product's packaging is made from environmentally friendly material and can be disposed of at your local recycling plant.

Customer Service

Please contact Angels Horn official customer service if there is any accessory missing from the package. Please retain the original packaging materials for exchange or return purposes.

US

To ensure speedy handling of your issue,
email us for assistance.
Email: support@angelshorn.com

UK/EU/CA

To ensure speedy handling of your issue,
please email us for assistance.
Email: services@angelshorn.com

Facebook: <https://www.facebook.com/AngelsHornPage>